

CRAFTLINE

Cabinetry

QUALITY • VALUE • STYLE

Base Cabinet Assembly Instructions

Base B09FH	Page 1
Base Base Corner Lazy Susan	Page 2
Base Double Door B24 B30 B33 B36	Page 3
Base Drawer Base (Kitchen & Vanity)	Page 4
Base Single Door 12 15 18 21	Page 5
Base Sink & Vanity Sink	Page 6
Base Vanity Combination Sink Base Three Drawer	Page 7
Base Vanity Combination Sink Base Two Drawer	Page 8

B09FH ASSEMBLY INSTRUCTIONS

Getting started:

prepare a protection layer, a screwdriver

STEP 1: Joint side panel with back panel

STEP 2: Joint bottom panel with side panel

STEP 3: Joint side panel with bottom & back panel





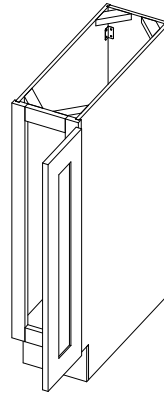

STEP 4: Attach frame on and toekick board

STEP 5: Attach the plastic block on the top corner

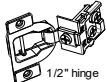
STEP 6: Fix door onto the frame and adjust the cover-space

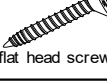

PARTS LIST		
NO.	Description	QTY
A	BACK PANEL	1
B	SIDE PANEL	2
C	TOP&BOTTOM PANEL	1
D	FACE FRAME	1
E	TOE KICK	1
F	CABINETS DOOR	1

8	1/2" HINGE	2	 1/2" hinge
7	3/4" ROUND HEAD SCREW	2	 3/4" round head screw
6	BUMPER	2	 Bumper
5	9/16" ROUND HEAD SCREW	40	 9/16" round head screw
4	CLEAT	10	 Cleat
3	1" FLAT HEAD SCREW FOR CARCASS	2	 1" flat head screw
2	Plastic Block	4	 plastic block
1	9/16" flat head screw	8	 9/16" flat head screw
NO.	Description	QTY	PICTURE
HARDWARE LIST			

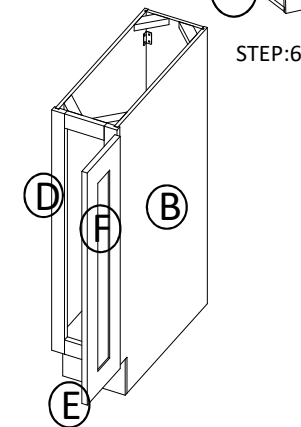
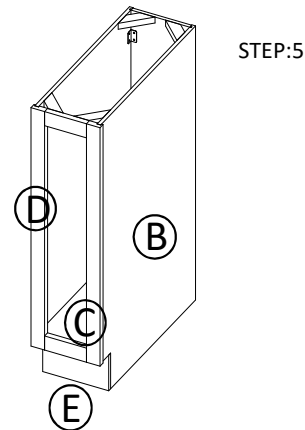
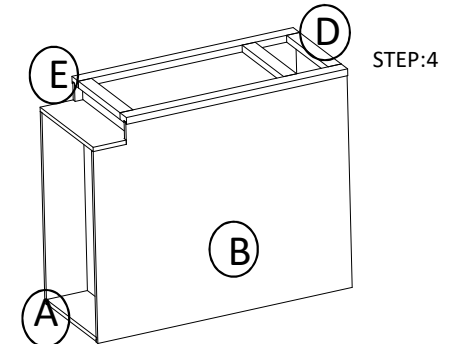
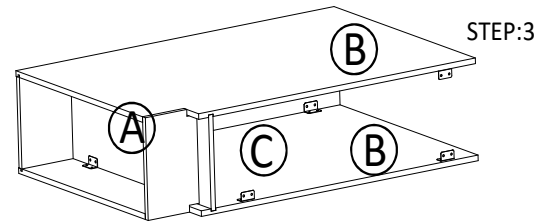
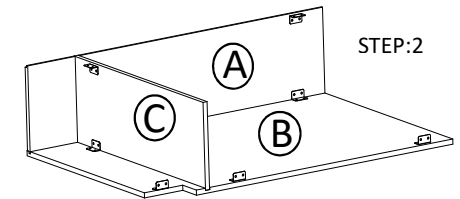
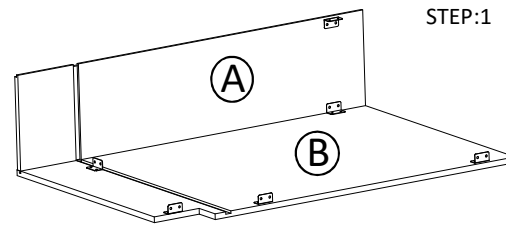

LSB33,LSB36

ASSEMBLY INSTRUCTIONS

Getting started:

prepare a protection layer, a screwdriver

STEP 1: Joint right side panel with right back panel

STEP 2: Fix the bottom panel on

STEP 3: Joint right side panel with right back panel

STEP 4: Attach toe-kick on

STEP 5: turn the carcass stand

STEP 6: Insert back panel through the groove



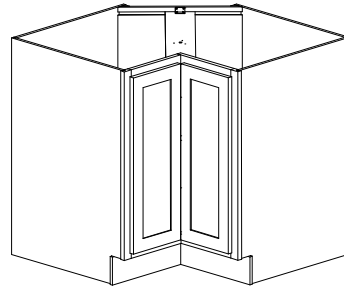

STEP 7: Attach face frame(long and short), then screw up

STEP 8: Attach top connect strip using screw and install plastic block

STEP 9: Hinge the door onto the face frame and adjust the cover-space

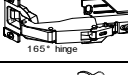
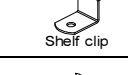
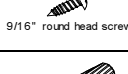

PARTS LIST		
NO.	Description	QTY
A	SIDE PANEL	2
B	BACK PANEL	2
C	TOP&BOTTOM PANEL	1
D	TOE KICK	1
E	TOE KICK	1
F	FACE FRAME	1
G	FACE FRAME	1
H	CONNECT STRIP	1
I	BACK PANEL	1
J	ADJUSTABLE SHELF	1
K	CABINETS DOOR	2

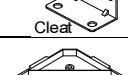
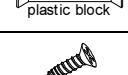
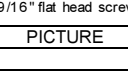
11	135 DEGREE HINGE	2	
10	3/4" ROUND HEAD SCREW	8	
9	BUMPER	4	
8	165 DEGREE HINGE	2	
7	SHELF CLIP	6	
6	9/16" ROUND HEAD SCREW	72	
5	DOWEL	6	
4	1" FLAT HEAD SCREW FOR CARCASS	11	
3	CLEAT	18	
2	Plastic Block	4	
1	9/16" flat head screw	8	

NO.	Description	QTY	PICTURE
-----	-------------	-----	---------

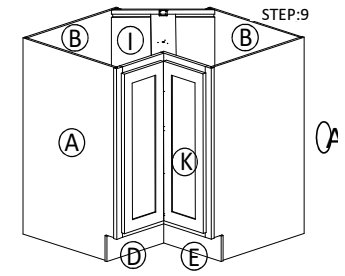
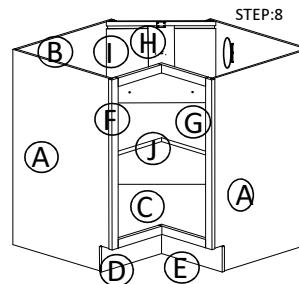
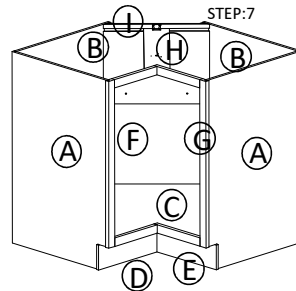
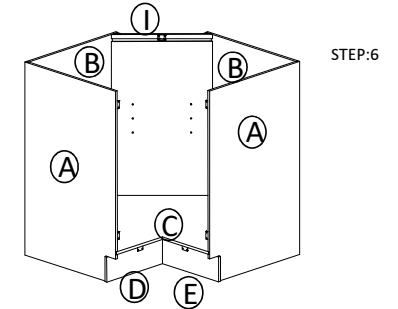
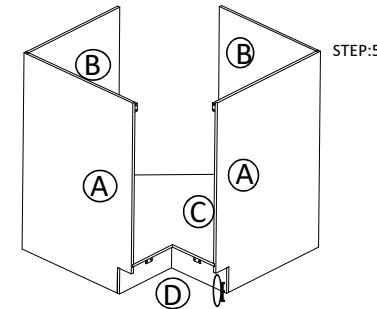
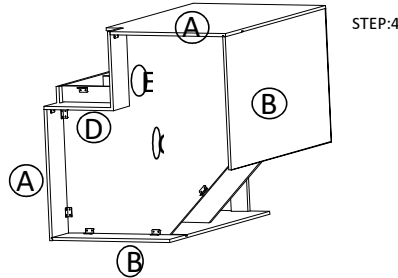
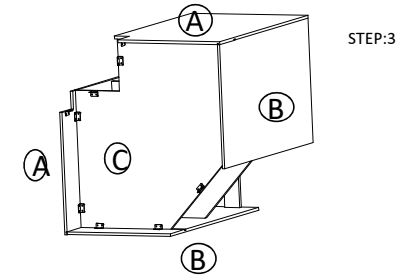
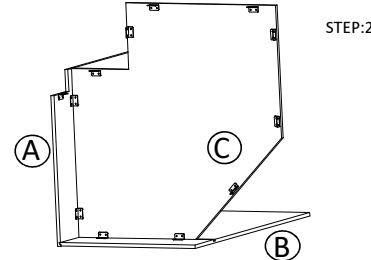
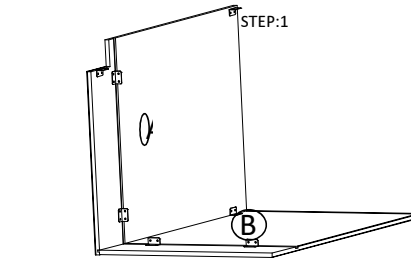

B24,B27,B30,B33,B36,
ASSEMBLY INSTRUCTIONS

Getting started:

prepare a protection layer, a screwdriver

STEP 1: Joint side panel with back panel

STEP 2: Joint bottom panel with side panel

STEP 3: Joint side panel with bottom & back panel

STEP 4: Attach frame on and toekick board

STEP 5: Joint the drawer together, then install the drawer guide.

STEP 6: Attach the plastic block on the top corner, and put on the adjustable shelf

STEP 7: Fix drawer head on the drawer front and fix door onto the frame and adjust the cover-space

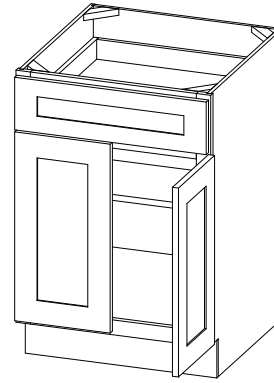

PARTS LIST		
NO.	Description	QTY
A	BACK PANEL	1
B	SIDE PANEL	2
C	TOP&BOTTOM PANEL	1
D	TOE KICK	1
E	FACE FRAME	1
F	DRAWER BOX FRONT AND BACK	2
G	DRAWER BOX SIDE	2
H	DRAWER BOX BOTTOM	1
I	ADJUSTABLE SHELF	1
J	DRAWER HEAD	1
K	CABINETS DOOR	2

11	1/2" HINGE	4	
10	3/4" ROUND HEAD SCREW	4	
9	BUMPER	8	
8	1" ROUND HEAD SCREW	4	
7	Epoxy Slide	1	
6	SHELF CLIP	4	
5	9/16"ROUND HEAD SCREW	44	
4	CLEAT	11	
3	1"FLAT HEAD SCREW FOR CARCASS	11	
2	Plastic Block	4	
1	9/16" flat head screw	18	
NO.	Description	QTY	PICTURE

HARDWARE LIST

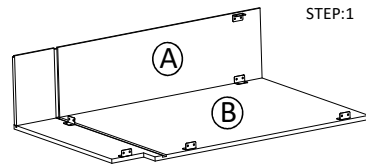

STEP:1

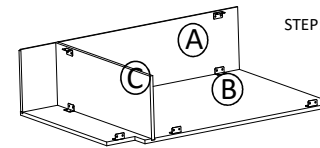

STEP:2

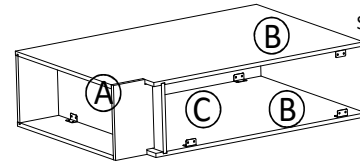

STEP:3

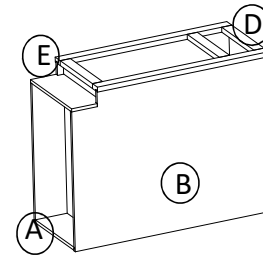

STEP:4

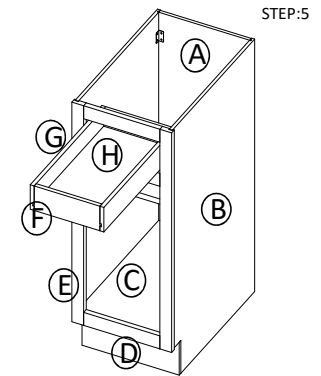

STEP:5

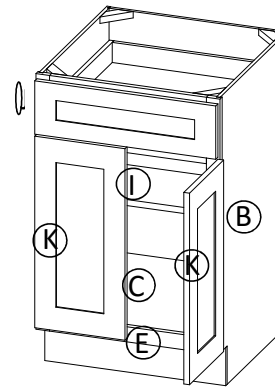
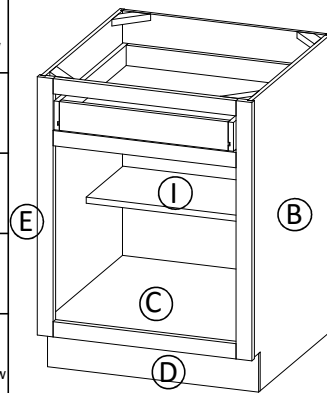

Epoxy sidemount drawer runners

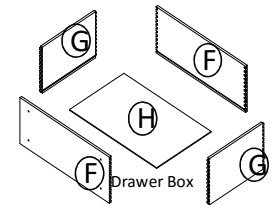
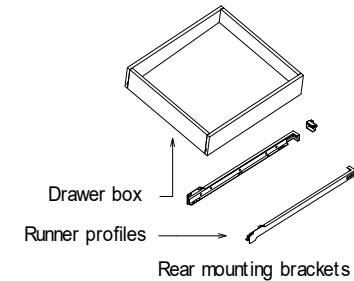

3DB12, 3DB15, 3DB18, 3DB21, 3DB24, 3DB30, 3DB36
 3VDB12, 3VDB15, 3VDB18

ASSEMBLY INSTRUCTIONS

Getting started:

prepare a protection layer, a screwdriver

STEP 1: Joint side panel with back panel

STEP 2: Joint bottom panel with side panel

STEP 3: Joint side panel with bottom & back panel

STEP 4: Attach frame on and toekick board





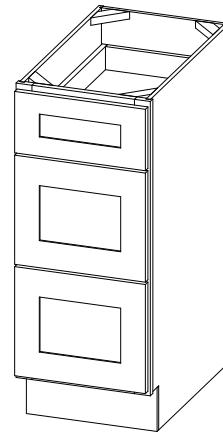

STEP 5: Joint the drawer together, then install the drawer guide.

STEP 6: Attach the plastic block on the top corner, and put on the adjustable shelf

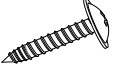
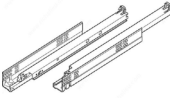
STEP 7: Fix drawer head on the drawer front and adjust the cover-space

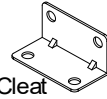

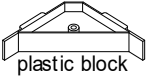
PARTS LIST		
NO.	Description	QTY
A	BACK PANEL	1
B	SIDE PANEL	2
C	TOP&BOTTOM PANEL	1
D	TOE KICK	1
E	FACE FRAME	1
F	DRAWER BOX FRONT AND BACK	6
G	DRAWER BOX SIDE	6
H	DRAWER BOX BOTTOM	3
I	DRAWER HEAD	3

8	BUMPER	12	 Bumper
7	1" ROUND HEAD SCREW	12	 1" round head screw
6	UNDER MOUNT SOFT CLOSE DRAWER SLIDE	3	
5	9/16" ROUND HEAD SCREW	40	 9/16" round head screw
4	CLEAT	10	 Cleat
3	1" FLAT HEAD SCREW FOR CARCASS	26	 1" flat head screw
2	Plastic Block	4	 plastic block
1	9/16" flat head screw	38	 9/16" flat head screw
NO.	Description	QTY	PICTURE

HARDWARE LIST

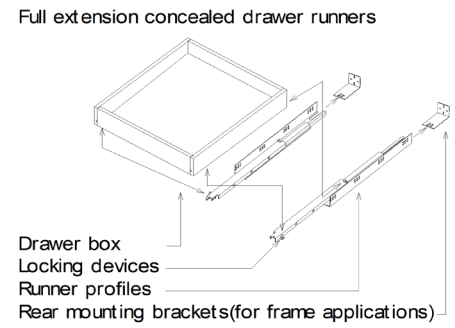
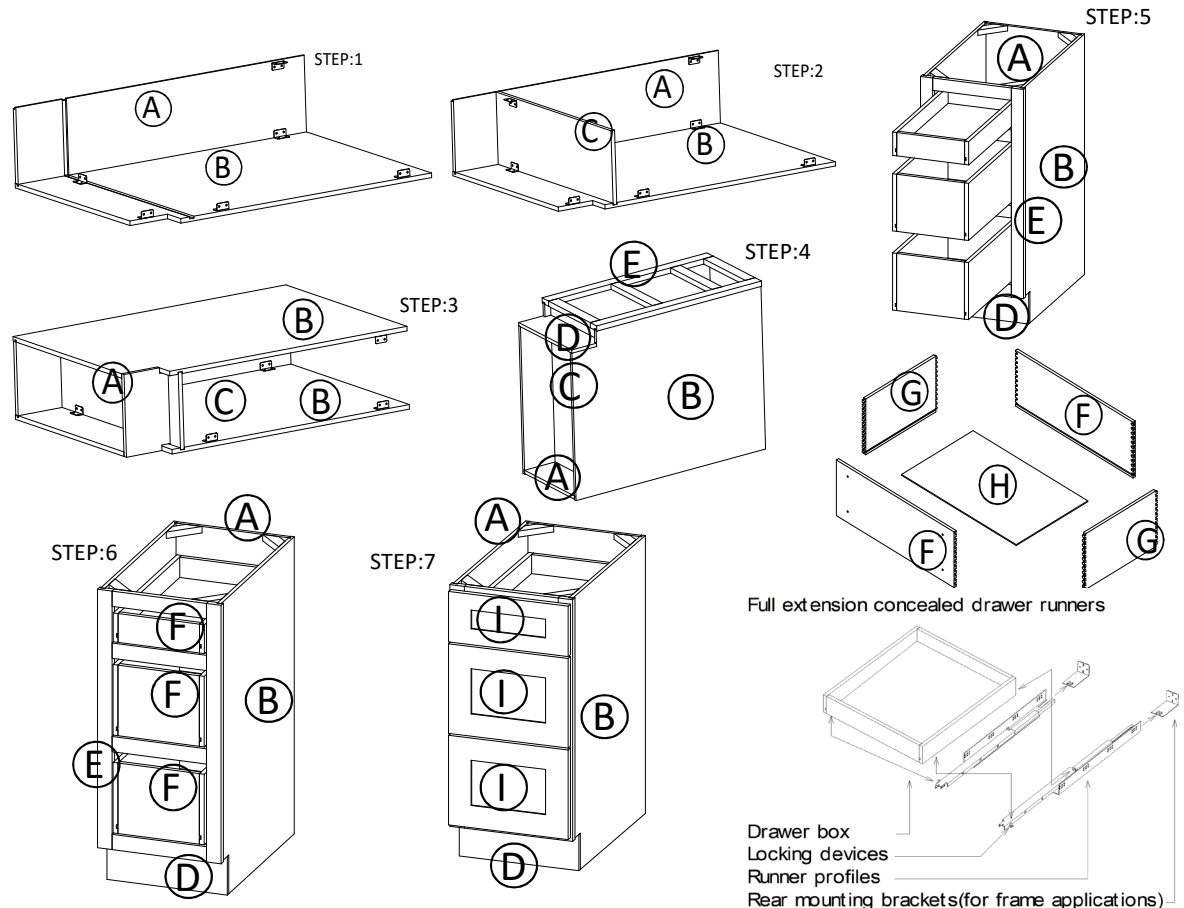

B12,B15,B18,B21

ASSEMBLY INSTRUCTIONS

Getting started:

Prepare a protection layer, a screwdriver

STEP 1: Joint side panel with back panel using 2 (NO.1) metal clips and 10 (NO.8) 1/2" flat head screw

STEP 2: Joint bottom panel with side panel









STEP 3: Joint the another side panel with bottom & back panel using 2 (NO.1) metal clips and 10 (NO.8) 1/2" flat head screw

STEP 4: Attach frame on and toekick board using 6 (NO.1) metal clips and 30 (NO.8) 1/2" flat head screw

STEP 5: Joint the drawer together, then install the drawer guide using 8 (NO.8) 1/2" flat head screw and 2 (No.5) 3/4" round head screw

STEP 6: Put on the adjustable shelf

STEP 7: Fix drawer head on the drawer box side and fix door onto the frame, each door using 2 (No.9) 1 1/4" hinge and 2 (No.5) 3/4" round head screw on frame and 4(No.6) 5/8" flat head screw on door, last adjust overlay

9	1 1/4" SOFTCLOSE HINGE	2	
8	1/2" FLAT HEAD SCREW (FOR METAL CLIP AND REAR BRACKET OF DRAWER SLIDE)	50	
7	BUMPER	6	
6	5/8" FLAT HEAD SCREW (HINGE ON DOOR)	6	
5	3/4" ROUND HEAD SCREW (HINGE ON FACE FRAME)	2	
4	BALL-BEARING SIDE MOUNT SLIDE	1	
3	SHELF CLIP	4	
2	1" FLAT HEAD SCREW FOR DF AND FRONTDRAWER BOX	6	
1	METAL CLIP	10	
NO.	DESCRIPTION	QTY	PICTURE

HARDWARE LIST

PARTS LIST		
NO.	DESCRIPTION	QTY
A	BACK PANEL	1
B	SIDE PANEL	2
C	TOP&BOTTOM PANEL	1
D	TOE KICK	1
E	FACE FRAME	1
F	DRAWER BOX BACK	2
G	DRAWER BOX SIDE	2
H	DRAWER BOX BOTTOM	1
I	ADJUSTABLE SHELF	1
J	DRAWER HEAD	1
K	CABINETS DOOR	1

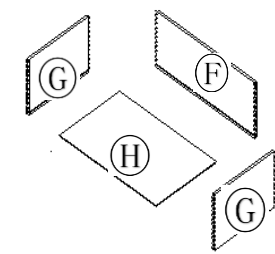
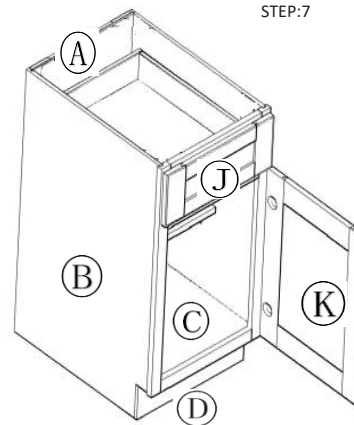
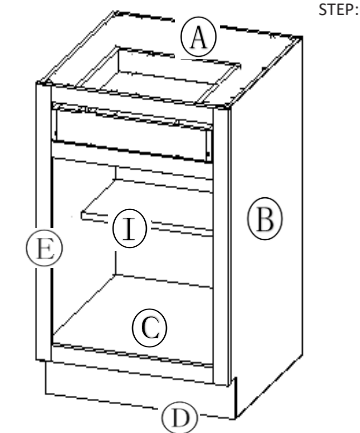
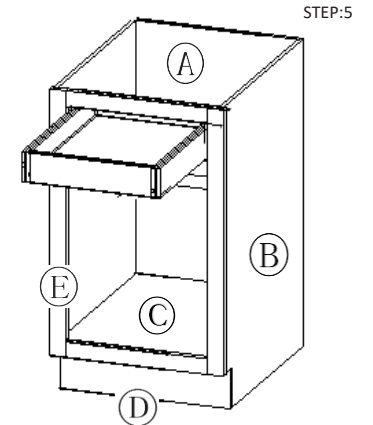
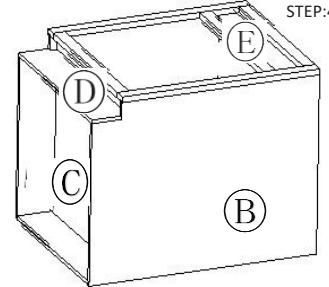
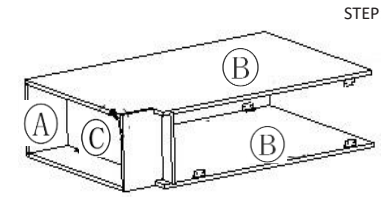
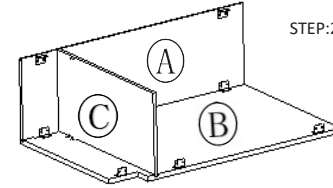
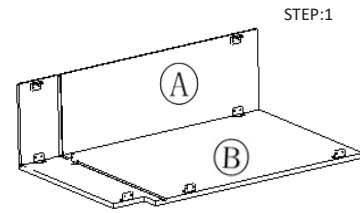
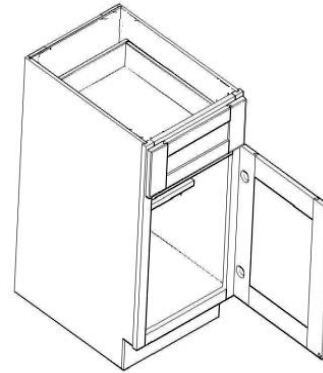

DRAWER BOX

ASSEMBLY INSTUCTIONS

VSB24, VSB30, VSB36
SB30, SB33, SB36

Getting started:

prepare a protection layer, a screwdriver

STEP 1: Joint side panel with back panel

STEP 2: Joint bottom panel with side panel

STEP 3: Joint side panel with bottom & back panel







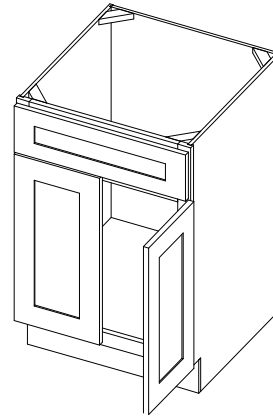

STEP 4: Attach frame on and toekick board

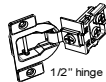
STEP 5: Attach the plastic block on the top corner, and put on the adjustable shelf

STEP 6: Fix door&drawer head onto the frame and adjust the cover-space

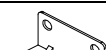
PARTS LIST		
NO.	Description	QTY
A	BACK PANEL	1
B	SIDE PANEL	2
C	TOP&BOTTOM PANEL	1
D	TOE KICK	1
E	FACE FRAME	1
F	CABINETS DOOR	2
G	DRAWER HEAD	1

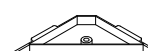

8	1/2" HINGE	4	 1/2" hinge
7	3/4" ROUND HEAD SCREW	4	 3/4" round head screw
6	BUMPER	4	 Bumper
5	9/16" ROUND HEAD SCREW	44	 9/16" round head screw
4	CLEAT	11	 Cleat
3	1" FLAT HEAD SCREW FOR CARCASS	3	 1" flat head screw
2	Plastic Block	4	 plastic block
1	9/16" flat head screw	8	 9/16" flat head screw
NO.	Description	QTY	PICTURE

HARDWARE LIST

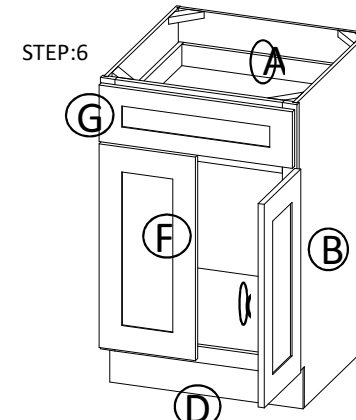
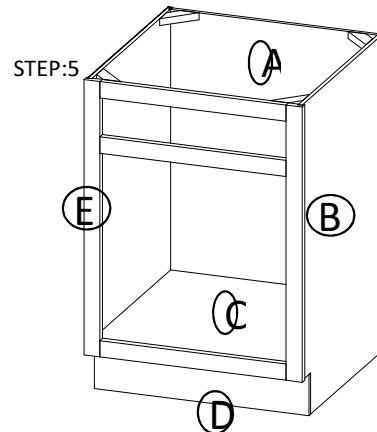
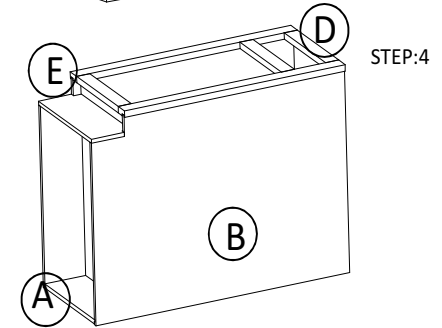
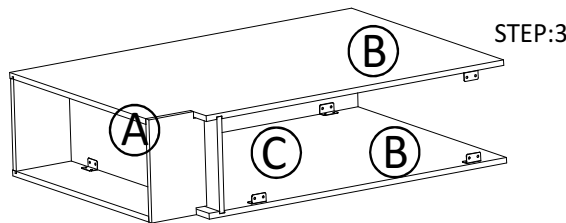
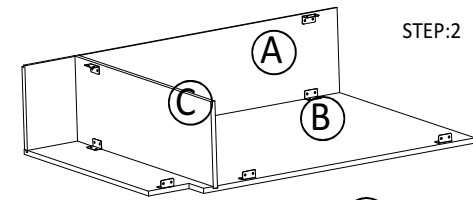
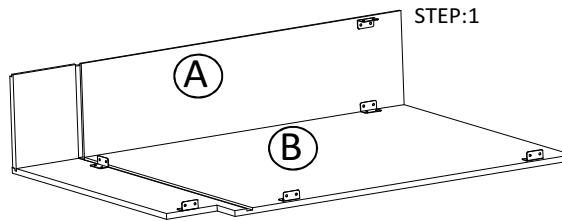

ASSEMBLY INSTRUCTIONS

VCD30DL3, VCD36DL3
VCD30DR3, VCD36DR3

Getting started:

prepare a protection layer, a screwdriver

STEP 1: Joint side panel with back panel

STEP 2: Joint bottom panel with side panel

STEP 3: Joint side panel with bottom & back panel

STEP 4: Attach frame on and toekick board

STEP 5: Joint the drawer together, then install the drawer guide.

STEP 6: Attach the plastic block on the top corner.

STEP 7: Fix drawer head on the drawer front and fix door onto the frame and adjust the cover-space

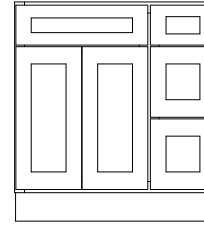
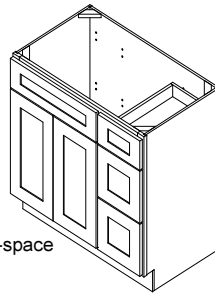



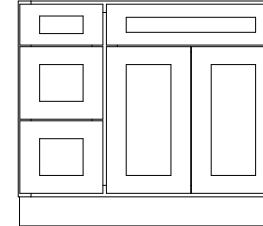







V3621DR



V3621DL

PARTS LIST		
NO.	Description	QTY
A	BACK PANEL	1
B	SIDE PANEL	2
C	TOP&BOTTOM PANEL	1
D	TOE KICK	1
E	FACE FRAME	1
F	DRAWER BOX FRONT AND BACK	6
G	DRAWER BOX SIDE	6
H	DRAWER BOX BOTTOM	3
I	CABINETS DOOR	2
J	DRAWER HEAD	4

10	1/2" HINGE	4	
9	3/4" ROUND HEAD SCREW	4	
8	BUMPER	16	
7	1" ROUND HEAD SCREW	12	
6	Undermount soft close drawer slide	3	
5	9/16" ROUND HEAD SCREW	44	
4	CLEAT	11	
3	1" FLAT HEAD SCREW FOR CARCASS	28	
2	Plastic Block	4	
1	9/16" flat head screw	38	
NO.	Description	QTY	PICTURE

HARDWARE LIST

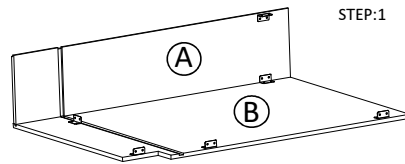

STEP:1

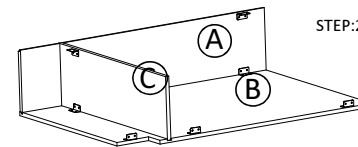

STEP:2

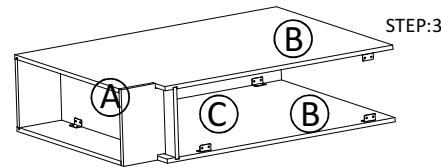

STEP:3

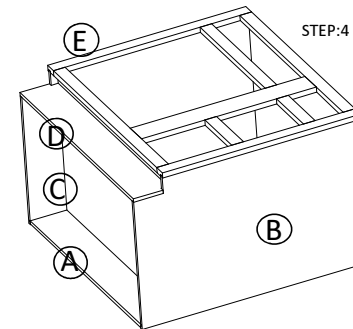

STEP:4

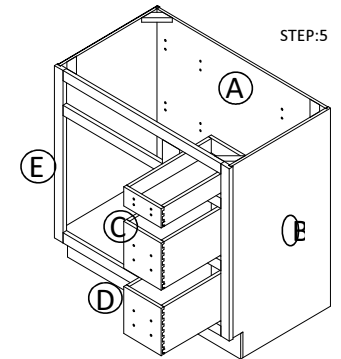

STEP:5

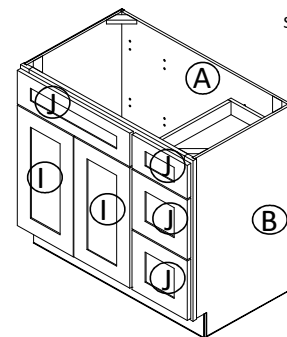

STEP:

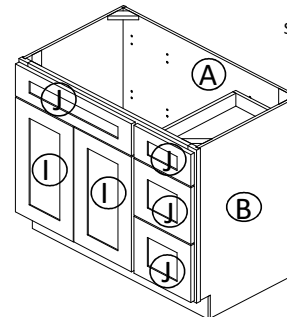

STEP:7

Full extension concealed drawer runners

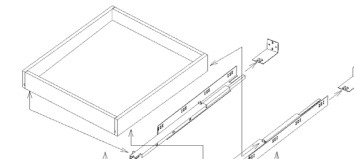

Drawer box
Locking devices
Runner profiles
Rear mounting brackets(for frame applications)

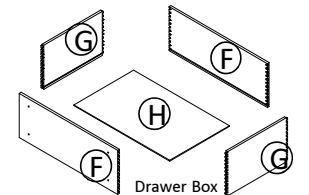

Drawer Box

ASSEMBLY INSTRUCTIONS

VCD30DL3, VCD36DL3
VCD30DR3, VCD36DR3

Getting started:

prepare a protection layer, a screwdriver

STEP 1: Joint side panel with back panel

STEP 2: Joint bottom panel with side panel

STEP 3: Joint side panel with bottom & back panel

STEP 4: Attach frame on and toekick board









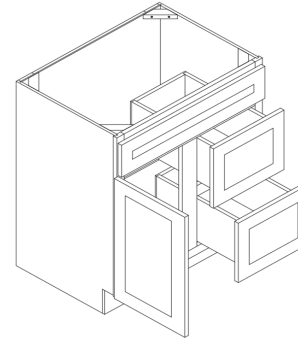

STEP 5: Joint the drawer together, then install the drawer guide.

STEP 6: Attach the plastic block on the top corner.

STEP 7: Fix drawer head on the drawer front and fix door onto the frame and adjust the cover-space

PARTS LIST		
NO.	Description	QTY
A	BACK PANEL	1
B	SIDE PANEL	2
C	TOP&BOTTOM PANEL	1
D	TOE KICK	1
E	FACE FRAME	1
F	DRAWER BOX FRONT AND BACK	6
G	DRAWER BOX SIDE	6
H	DRAWER BOX BOTTOM	3
I	CABINETS DOOR	2
J	DRAWER HEAD	4



10	1/2" HINGE	4	
9	3/4" ROUND HEAD SCREW	4	
8	BUMPER	16	
7	1" ROUND HEAD SCREW	12	
6	Undermount soft close drawer slide	3	
5	9/16" ROUND HEAD SCREW	44	
4	CLEAT	11	
3	1" FLAT HEAD SCREW FOR CARCASS	28	
2	Plastic Block	4	
1	9/16" flat head screw	38	
NO.	Description	QTY	PICTURE

HARDWARE LIST

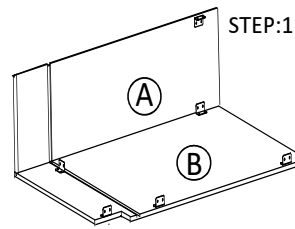

STEP:1

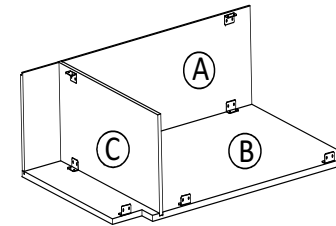

STEP:2

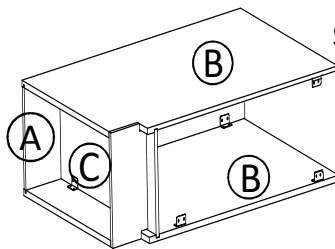

STEP:3

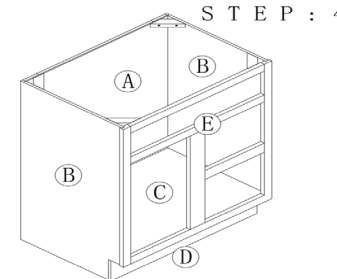

STEP : 4

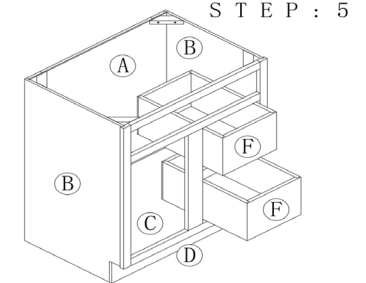

STEP : 5

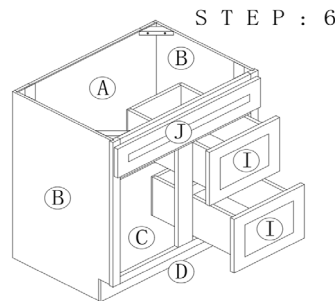

STEP : 6

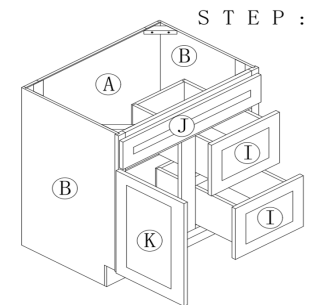

STEP : 7