

Inswing Closer Kit

Installation Instructions

- It is the responsibility of the installer to meet all code and safety requirements, and to obtain all required building permits. The installer should determine and implement the installation techniques appropriate for each unique installation situation. Digger Specialties, Inc. and its distributors shall not be held liable for improper or unsafe installations.

Install Handle Assembly and Latch

Note: Inswing closer kit hardware can be installed on left or right side of inswing door. Right side installation is shown in illustrations below. Lock on inside handle will be positioned on top of handle on left side installations. Parts are listed on back of sheet.

Tools needed: Screw gun, drill, 1/4" drill bit, 1/8" drill bit, Phillips screw driver, #2 square head bit

- After door is installed determine location of handle assembly on door. With screen door in closed position use template provided in inswing hardware kit to mark latch location on door jamb and locations for three 1/4" holes on door for handle installation (Fig. 1).

- Drill three 1/4" holes straight through door frame for handle assembly.

- Assemble handle components and use two 1 1/4" machine screws to secure the two handles together (Fig. 2).

- Attach latch to door jamb by predrilling two 1/8" holes and using two 1 1/4" wood screws to fasten latch to door jamb (Fig. 3).

- Make sure that door opens and closes freely and door latches securely before installing closer tube.

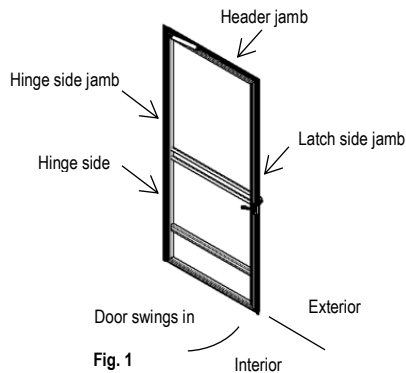

Fig. 1

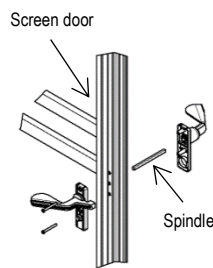

Fig. 2

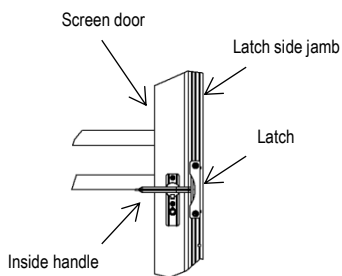

Fig. 3

Install Closer Tube

- Closer tube will be installed on top door rail (Fig. 4).

- Install door closer bracket 2" in from edge of door on hinge side. Verify that the closer tube will clear top of door before attaching door closer bracket. Use three 5/8" self-tapping screws to attach door closer bracket to door.

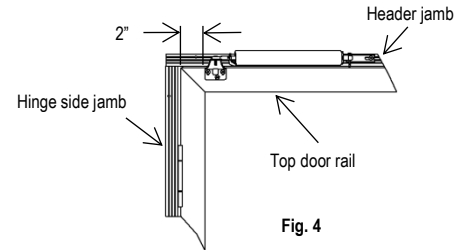

Fig. 4

- Use short connecting pin to attach closer tube to door closer bracket.

- Pull on closer tube and position hold open washer on closer tube rod in front of lugs on closer tube rod (Fig. 5). This allows tension to be on closer tube after installation is complete.

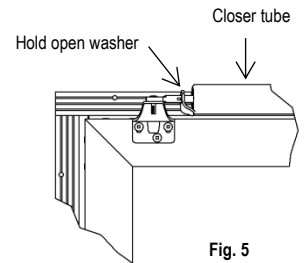

Fig. 5

- Make sure that door is closed and latched. Mark location of jamb closer bracket on header jamb. Use two 5/8" self-tapping screws to fasten jamb closer bracket to header jamb.

- Attach closer tube to jamb closer bracket with long connecting pin.

- Open door slightly and release hold open washer on closer tube rod to allow door to close completely (Fig. 6).

- Adjust closer tube speed by turning valve screw on end of closer tube. Turn screw clockwise to decrease speed and counterclockwise to increase speed.

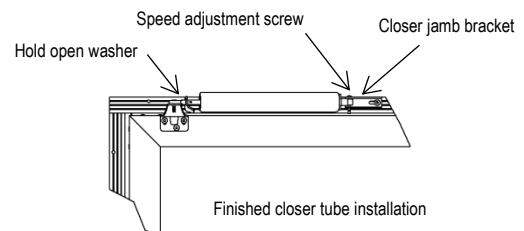

Fig. 6

Inswing Closer Kit

Installation Instructions

- It is the responsibility of the installer to meet all code and safety requirements, and to obtain all required building permits. The installer should determine and implement the installation techniques appropriate for each unique installation situation. Digger Specialties, Inc. and its distributors shall not be held liable for improper or unsafe installations.

Inswing Closer Kit

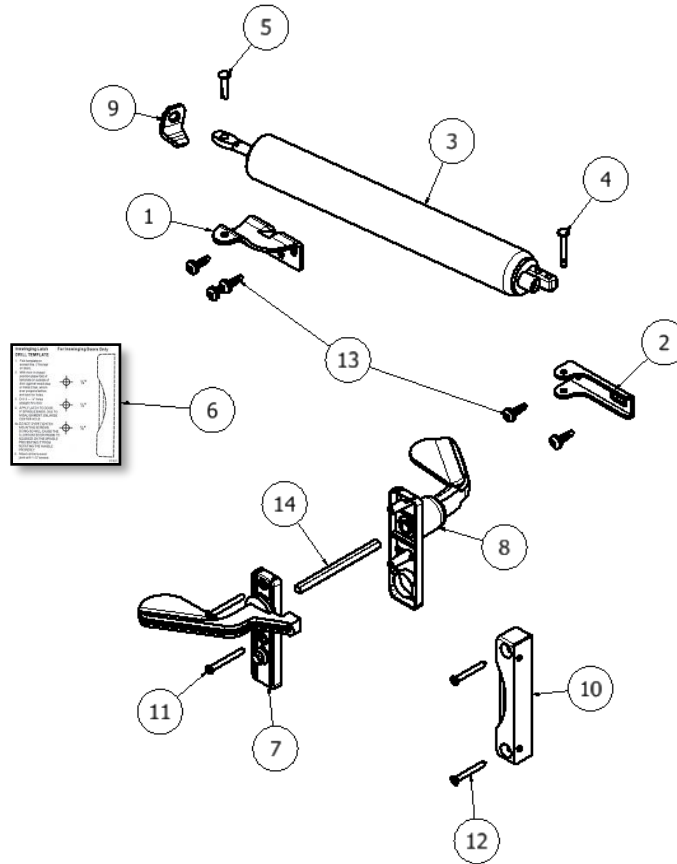

PARTS LIST		
ITEM	QTY	PART NUMBER
1	1	Closer Bracket_Door
2	1	Closer Bracket_Jamb
3	1	Closer Tube
4	1	Connector Pin Long
5	1	Connector Pin Short
6	1	Drill Template
7	1	Handle Inside
8	1	Handle Outside
9	1	Hold Open Washer
10	1	Latch
11	2	Screw #6-32 x 1 1/4 Machine
12	2	Screw #8 x 1 1/4 Wood
13	5	Screw #10 x .625 TEK Round Head
14	1	Spindle